

Trinocular Microscope Camera Solution② (Smart Camera) User Manual

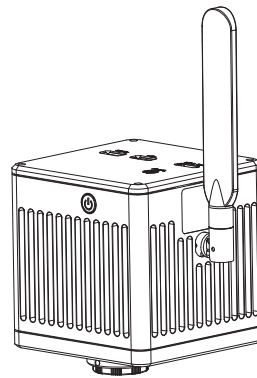
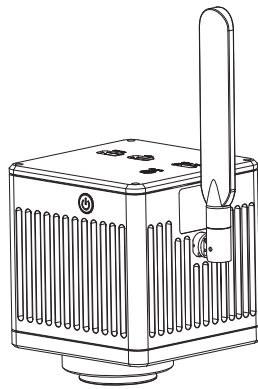

Applicable brand	Olympus	Nikon	Leica	Zeiss
C-mount model	HW1200Z			
Dovetail mount models	BC1200(O)	BC1200(N)	BC1200(L)	BC200(Z)
Category	N/A			
Physical resolution	12.0MP			

Olympus	Nikon	Leica	Zeiss
CS20			
YS20			
A0	N2	L0	Z0
20.0MP			

Content

Chapter 1 Notes And Safety Requirements	- 1 -
1.1 Cautions and notes	- 1 -
Chapter 2 Package List	- 2 -
Chapter 3 Hardware introduction	- 3 -
Chapter 4 Installation methods	- 4 -
4.1 Camera install to a trinocular microscope	- 4 -
4.2 Remove camera from microscope	- 4 -
4.3 Par-focal(only for dovetail models)	- 5 -
Chapter 5 Connection Methods	- 5 -
5.1 HDMI connection	- 5 -
5.2 5G WiFi connection	- 5-7 -
5.3 Local area network connection	- 7-8 -
Chapter 6 The Function Introduction And Connection Way For Video Set-top Box (Optional Accessory)	- 9 -
6.1 Packing list	- 9 -
6.2 Advantages and connection of video set-top boxes	- 10 -
Chapter 7 Troubleshooting And Frequently Asked Questions	- 11 -
7.1 Abnormal power-on status problems	- 11 -
7.2 Image problems	- 11 -
7.3 Interface problems	- 11 -
Chapter 8 Disclaimer	- 12 -

1.1 Cautions and notes

- (1) To avoid danger or damage incurred to the lens, do not touch the lens or sensor directly with your fingers.
- (2) To avoid failure or electric shock hazard and so on, do not disassemble or modify the internal structure of the device.
- (3) Do not plug in or unplug the USB port or the HDMI port when hands are wet.
- (4) Do not use alcohol and other organic solvents to clean.
- (5) If the lens or sensor is dirty or damp, you should better use dry and non-linen fabric or professional lens tissue to wipe them. To avoid scratches on the surface, do not touch the lens with your fingers. Wipe the lens or sensor lightly.
- (6) The products are not specifically designed for an outdoor use. Do not expose it to outdoor environment without any protection. Excessive temperature and humidity will damage the lens. Please avoid using the product under the following environment: high temperature or high humidity environment, places with direct sunlight, dirt or vibration and places near heat source.
- (7) Please use and store in the following environment:
 - Operating temperature : 0°C~ 40°C;
 - Storage temperature: -10°C~ 60°C;
 - Operating Humidity : 30~60%RH;
 - Storage Humidity: 10~80%RH.
- (8) If any foreign matter, water or liquid enter into the device by accident, disconnect the USB cable immediately. Please send it to the maintenance center and do not use the hair dryer to dry it by yourself.
- (9) To prevent microscope from being tripped over or dropped, please put away the device's USB cables in use or standby.
- (10) To avoid electric shock by accident, please power off microscope before you move your Windows PC or laptop.
- (11) The cleanliness of the device lens will directly affect clarity degree of contents from the computer screen during preview. Problems like various circles or spots on the screen may mostly be incurred by dirt on the lens. When cleaning, please use professional lens tissue or other professional detergent to clear the dirt on the lens.
- (12) Registered trademark and copyright information: this product is copyrighted by GUANGZHOU OSTECH ELECTRONIC TECH-NOLOGY CO.,LTD. Without written authorization of the company, any organization or individual shall not copy, print or translate any part of this article into another language.

Chapter 2 Package List

1. Smart camera (C-mount or dovetail mount)



2. HDMI cable (2m)



3. Wired mouse and keyboard



4. Allen key (3mm)

(only for dovetail mount)



5. Power adapter and power cord

(Optional Chinese, American, European, Australian, Korean, British standard, etc.)



6. One paper with QR code and link to download software

Software、Manual Download 软件、说明书下载



Windows Download
PC软件下载

Windows download link:
PC软件下载链接:
<https://ostec.com.cn/downloads/>



For 5.0/8.0MP



For 12.0MP



KoPa WiFi Lab For Android/iOS Download
KoPa WiFi Lab 安卓/iOS 软件下载



软件说明书下载



Software Manual Download

7. Video set-top box (optional)

Product model: NA001



Chapter 3 Hardware Introduction

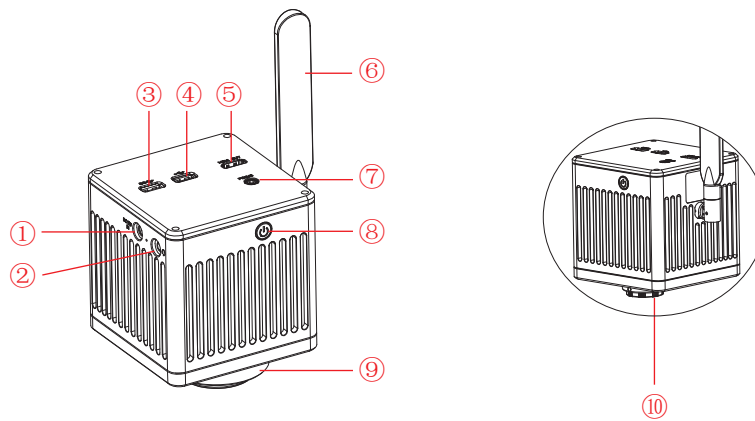

①	Power input interface (DC 12V 5A)	connect with the adapter in the accessories to achieve power supply to the camera.
②	Headphone and microphone interface	connect with headset cable to achieve transmission of audio signals.
③	USB 3.0 interface	can be connected to a mouse, keyboard, U disk, convenient for the use of software.
④	USB 2.0 interface	can be connected to a mouse, keyboard, U disk, convenient for the use of software.
⑤	HDMI output interface	through HDMI cable, connect with external monitor with HDMI interface to realize video, signal transmission, etc.
⑥	5G WiFi antenna	enhance the 5G WiFi signal transmission, to achieve wireless connection to the camera for image acquisition.
⑦	Easy focus hole (only for dovetail mount model)	internal filament focus structure is used to adjust the 0.43X field lens of the camera to achieve par-focal with electronic imaging and observation under eyepiece.
⑧	Power switch	switch on and off. Keep press for 4 seconds to power on / off.
⑨	Dovetail mount	connect with the dovetail slot on the trinocular microscope.
⑩	Standard C-mount	connect with trinocular microscope which has C-mount.

4.1 Camera install to a trinocular microscope

- (1) Remove the dust cover of microscope dovetail slot or standard C -mount, as shown in Figure 1.
- (2) Snap the camera onto the dovetail slot or screw it onto the standard C -mount of the microscope, oriented as in Figure 2; tighten the fastening screws on the dovetail slot of the microscope, fix the camera on the microscope.

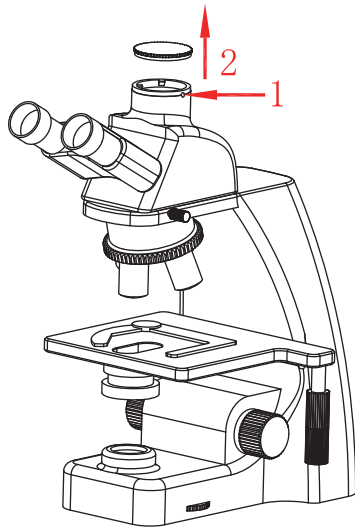

Figure 1

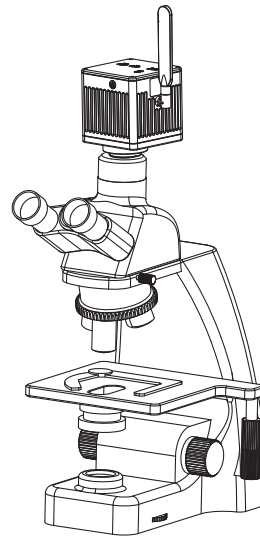

Figure 2

4.2 Remove camera from microscope

Reverse the order with the installation.

4.3 Par-focal (only for dovetail models)

- (1) Place a specimen under microscope, adjust diopter of the eyepiece to the minimum value, and use the 10X objective lens, recommend to focus on any black spot / or the darkest spot on the specimen, until the visualization is the clearest;
- (2) Adjust the easy focus hole in clockwise or counterclockwise direction with the Allen key until the image from software is clear to achieve par-focal;
- (3) Once par-focal under 10X objective is completed, the other objectives are basically free of adjustment and achieve par-focal as well.

Chapter 5 Connection Methods

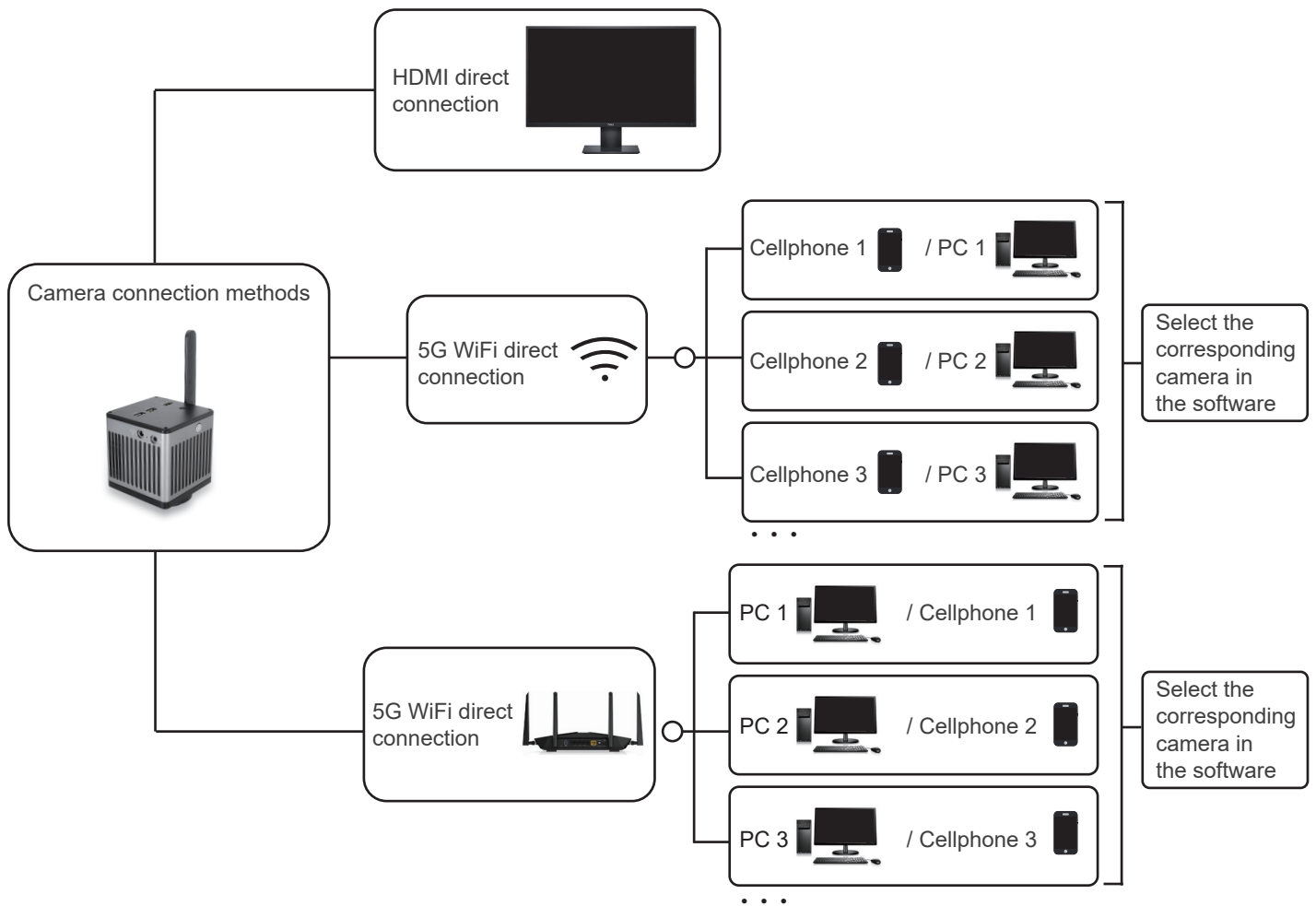

5.1 HDMI connection

- (1) HDMI-connected display to be provided by user, recommended Dell 24~27-inch high color gamut display.
- (2) Since the smart camera has a built-in Android operating system, the software KoPa WiFi Lab AO will be displayed on the monitor to control the smart camera after the external monitor is connected to the camera via HDMI. Support HDMI and 5G WiFi output at the same time.

5.2 5G WiFi connection

Desktop computers, cell phones, tablets, and laptops can be connected to the camera via 5G WiFi, supports multiple desktop computers, cell phones, tablets and laptops can realize microscopic view on the same screen.

5.2.1 Windows PC software KoPa Capture Pro download link

<https://cn.ostec.com.cn/downloads/>;

Please refer to the "KoPa Capture Pro Software User Manual" for details.

Windows System Requirements

Microsoft Windows 10 (64 bit) or later version operating systems.

CPU: i5 8th generation or later version.

Hard drive: 512GB or more.

Memory: 16GB or more.

Graphics card: Core graphics.

Network card: 10/100/1000M adaptive. Wireless NIC supports 5G WiFi IEEE802.11ac.

5.2.2 Connection method for cell phones or tablets

Android System Requirements

Android System 7.0 or later version.

CPU dual-core 1.7Ghz or later version.

Memory RAM 3GB or more.

Storage ROM 32GB or more.

Support wireless protocol 5G WiFi IEEE802.11ac.

iOS System Requirements

iOS System 11.0 or later version.

CPU dual-core 1.8Ghz or later version.

Memory RAM 2GB or more.

Storage ROM 32GB or more.

Support wireless protocol 5G WiFi IEEE802.11ac.

(1) Download and install the APP:

- 1) Click "KoPa WiFi Lab AO" software top left corner  " settings icon, the bottom left corner will appear double QR codes.
- 2) The QR code on the left is used to download APP, WeChat code sweeping function does not support downloading APP, please use a browser or QR code of your cell phone or tablet to scan the QR to link to official website.
- 3) Official website link: <https://cn.ostec.com.cn/downloads/>.
- 4) Choose KoPa WiFi Lab for Android or KoPa WiFi Lab for iOS to download and install according to your phone and tablet system.
- 5) You can search and download KoPa WiFi Lab from Google Play app store.
- 6) You can search and download KoPa WiFi Lab from Apple App Store.

(2) Scan QR code to live stream image automatically:

- 1) Run the built-in App KoPa WiFi Lab AO.
- 2) Click the QR code on the right to enlarge.

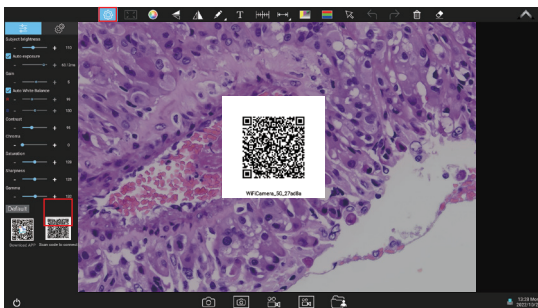

- 3) Click the  button on the navigation interface, scan the QR code on the camera body to connect to the microscope, no need to enter password, realize the same screen view.



(3) Manual connection method:

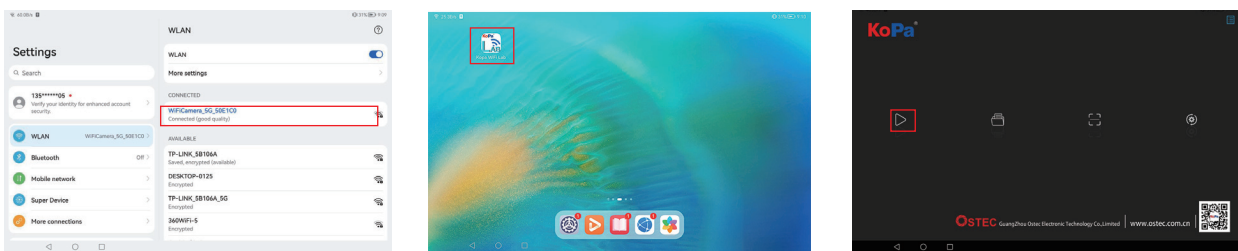

- 1) Search for the camera's WiFi SSID: WiFi5Camera_xxxxxx in the WLAN of phone or tablet; default connection password: 12345678.
- 2) Run the App KoPa WiFi Lab, enter the App KoPa WiFi Lab navigation interface, and click  the button to connect to the microscope manually.



5.3 Local area network connection

Once the camera connected to a local area network, it can be changed to a network camera. Multiple desktop computers, cell phones, tablets and laptops on the same local area network can realize synchronized real-time preview.

5.3.1 The method for connect the camera to a local area network

- (1) Click the "" setting icon in the upper left corner of KoPa WiFi Lab AO;
- (2) Click the icon "";
- (3) Click the icon "" at the bottom left, Open WLAN (as in Figure 1 and 2);
- (4) Select a local area network (Figure 3), enter password and click "Connect" button.

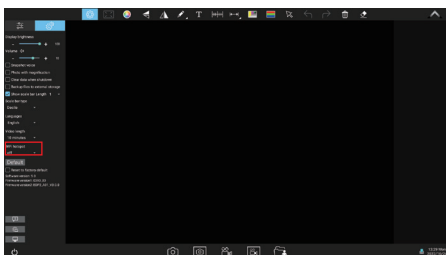

Figure 1

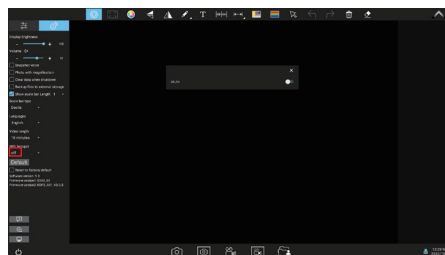

Figure 2

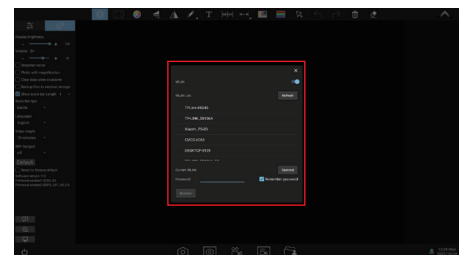

Figure 3

Notes:

- 1) The local area network must support 5G WiFi IEEE802.11ac protocol, otherwise it cannot be displayed in the list.
- 2) If the local area network opens the Internet function, the camera can also access the Internet.

5.3.2 Retrieve images via the local area network from a Windows PC on the same local area network

- (1) Connect a Windows PC or laptop that supports 5G WiFi IEEE802.11ac protocol to the same local area network as the camera.
- (2) Install and run the software KoPa Capture Pro on the Windows PC or laptop.
- (3) When there is only one network camera in the local area network, the software can automatically get the live image from the camera.
- (4) When there are multiple network cameras in the same local area network, click the icon "📷" in the upper right corner of KoPa Capture Pro (Figure 1), the list automatically shows all cameras in the current local area network (Figure 2), select a camera as needed, support switching midway at any time.

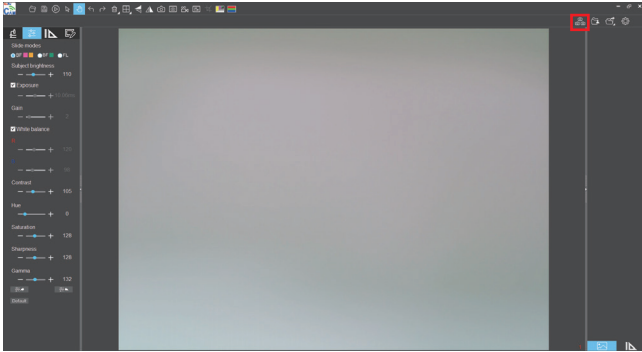

Figure 1

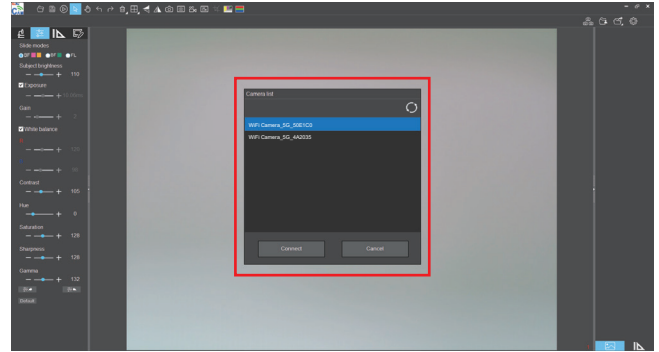

Figure 2

Notes:

When a Windows PC or laptop computer accesses the camera images, it does not affect the computer's ability to access the Internet, and if that local area network is open to the Internet, the Windows PC or laptop can also access the Internet.

5.3.3 Retrieve images via the local area network from cell phones and tablets in the same local area network

- (1) Connect the cell phone or tablet that supports 5G WiFi IEEE802.11ac protocol to the same local area network as the camera.
- (2) Install and run the App KoPa WiFi Lab on the phone or tablet, enter the navigation interface and click the "▶" button.
- (3) When there is only one network camera in the local area network, the App can automatically get the live image from the camera.
- (4) When there are multiple network cameras in the same local area network, click the icon "⚙️" in the navigation interface (Figure 1), pop-up menu (Figure 2). The list automatically shows all cameras in the current local area network (Figure 3), select a camera as needed, support switching midway at any time.

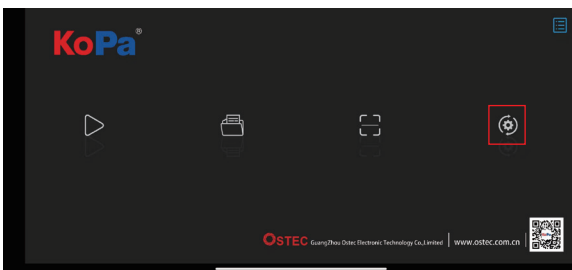

Figure 1

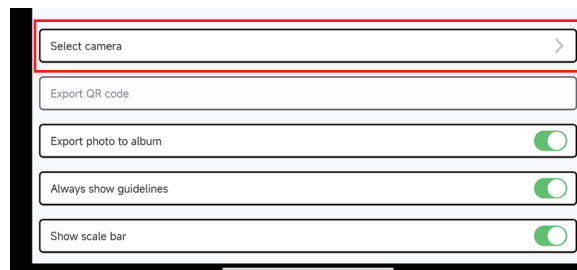

Figure 2

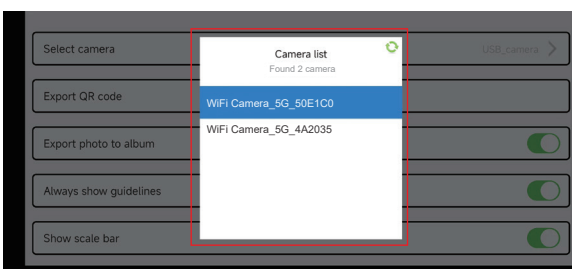

Figure 3

Chapter 6 The Function Introduction And Connection Way For Video Set-top Box (Optional Accessory)

6.1 Packing list

1.Video set-top box (optional)

Product model: NA001



2.HDMI cable (2m)



3.Wired mouse and keyboard



4.Power adapter and power cord

(Optional Chinese, American, European, Australian, Korean,British standard,etc.)



6.2 Advantages and connection of video set-top boxes

6.2.1 Advantages

- (1) It is suitable for applications such as pathology seminars, demonstration teaching, and video sharing on the large display screens in research institutes.
- (2) It supports the whole series of KoPa smart display camera, smart camera and WiFi cameras, and the factory has built-in high performance APP--KoPa WiFi Lab, which automatically connects with camera when it is turned on.
- (3) Built-in Android operating system, even if the large display screen has no operating system, it can wireless connect to the whole series of KoPa smart display camera, smart camera and WiFi cameras.

6.2.2 Connection

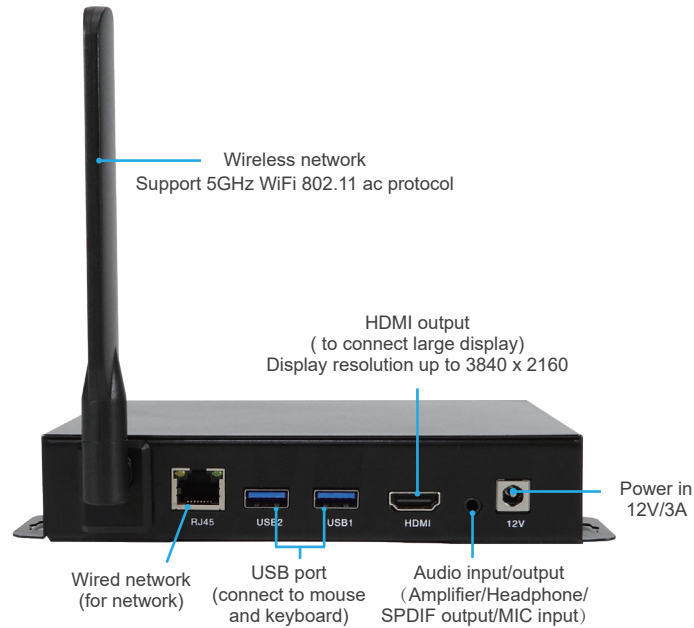

- (1) Connect the video set-top box to the oversized display with an HDMI cable, the display resolution supports up to 3840x2160.
- (2) The network cable is plugged into the video set-top box's wired network interface to give the video set-top box Internet access.
- (3) USB interface connects mouse and keyboard to facilitate the operation of the APP (KoPa WiFi Lab) on the oversized display.
- (4) Switching method for multiple network cameras in the same local area network:

Go to the APP (KoPa WiFi Lab) navigation interface, click the icon "⚙️" in the right (Figure 1), pop-up menu (Figure 2). The list automatically shows all cameras in the current local area network (Figure 3), select a camera as needed, support switching midway at any time.

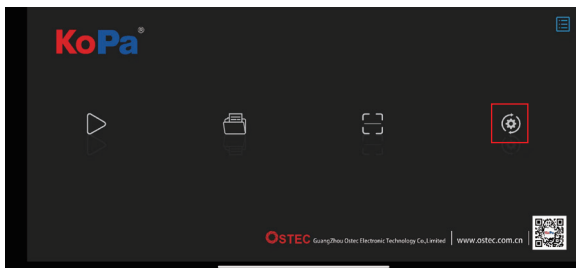

Figure 1

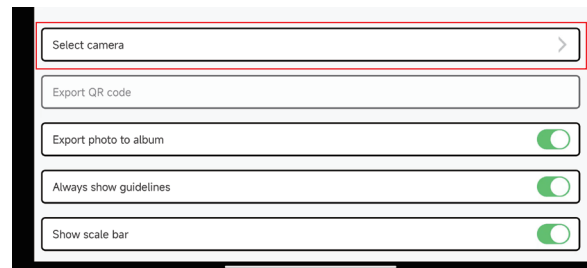

Figure 2

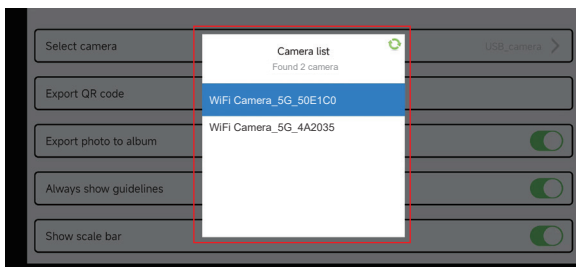

Figure 3

7.1 Abnormal power-on status problems

7.1.1 Unable to turn on the power (the power indicator light is not on)

- (1) Ensure that both ends of the power cord are plugged into the power socket and the power jack of the camera;
- (2) Ensure that the power on button has been long pressed for ≥ 4 seconds to turn on the camera. If the power indicator light still does not light up and the camera still cannot be turned on, please contact our customer service.

7.1.2 Unable to power on (the power indicator light is on)

- (1) Keep press the power switch for 4 seconds to turn off the camera, and keep press the power switch for 4 seconds to turn on the camera;
- (2) If the power still cannot be turned on, please contact our customer service.

7.1.3 Software abnormal or stay on boot up

- (1) Keep press the power switch for 4 seconds to turn off the camera, and keep press the power switch for 4 seconds to turn on the camera;
- (2) If the fault cannot be eliminated after restarting the camera, please contact our customer service.

7.2 Image problems

7.2.1 Image capture failure

- (1) Ensure that the microscope has turned on the light and the image is visible to the eyepiece;
- (2) Keep press the power switch for 4 seconds to turn off the camera, and keep press the power switch for 4 seconds to turn on the camera;
- (3) If the fault cannot be eliminated after restarting the camera, please contact our customer service.

7.3 Interface problems

7.3.1 the USB socket is not working

- (1) Ensure that the mouse and keyboard are working properly;
- (2) Confirm that the USB socket is still not working after replacing mouse and keyboard, please contact our customer service.

7.3.2 External HDMI monitor does not display

- (1) Ensure the HDMI cable can be used normally;
- (2) Ensure that the external HDMI monitor can support 3840x2160 30Hz;
- (3) If faulty cannot be eliminated, please contact our customer service.

7.3.3 No sound from headphone jack

- (1) Ensure the headset currently in use can be used normally;
- (2) Confirm that the headphone jack is still not working after replacing the headphones, please contact our customer service.

Chapter 8 Disclaimer

(1) In order to protect the legitimate rights and interests of users, please carefully read the instructions, disclaimers and safety instructions provided with this product before using it. The company reserves the right to update the above documents. Please operate the product according to the instructions and safety instructions.

(2) Once you begin to use the product, you shall be deemed to have read, understood, recognized and accepted all terms and contents of the product's instructions, disclaimers and safety instructions. Users undertake to be responsible for their actions and all consequences. User undertakes to use the product only for legitimate purposes and agrees to these terms and any relevant policies or guidelines that the company may establish.

(3) In the process of using this product, please strictly abide by and execute the requirements including but not limited to the instructions and safety instructions. All personal injuries, accidents, property losses, legal disputes and other adverse events that cause conflicts of interest caused by violation of the safety instructions or irresistible factors shall be borne by users themselves, and the company shall not assume any responsibility.

(4) Safety instructions:

- 1) Please do not use wet hands to plug and unplug the power supply of the equipment.
- 2) Please be sure to use a regular brand power socket, and make sure the grounding is well grounded to prevent electric shock.
- 3) Please be sure to make regular safety checks on sockets and plugs to avoid potential electrical safety hazards caused by aging and short circuit.
- 4) Please be sure not to use the product in a humid or hot environment to ensure the safety of the product.
- 5) Please be sure to loosen bundle cords of the power cable before using, to avoid electromagnetic induction and heating, thus increasing the heat dissipation speed.
- 6) Please be sure not to use the product equipment or socket or other places in high or easy to fall, so as to avoid damage.
- 7) Before opening the socket power supply, please be sure to turn off the load power switch of the product equipment.
- 8) The company reserves the rights to improve product, upgrade technology and change parameters without prior notice.

GUANGZHOU OSTECH ELECTRONIC TECHNOLOGY CO.,LTD.
<http://www.ostec.com.cn>